

本体

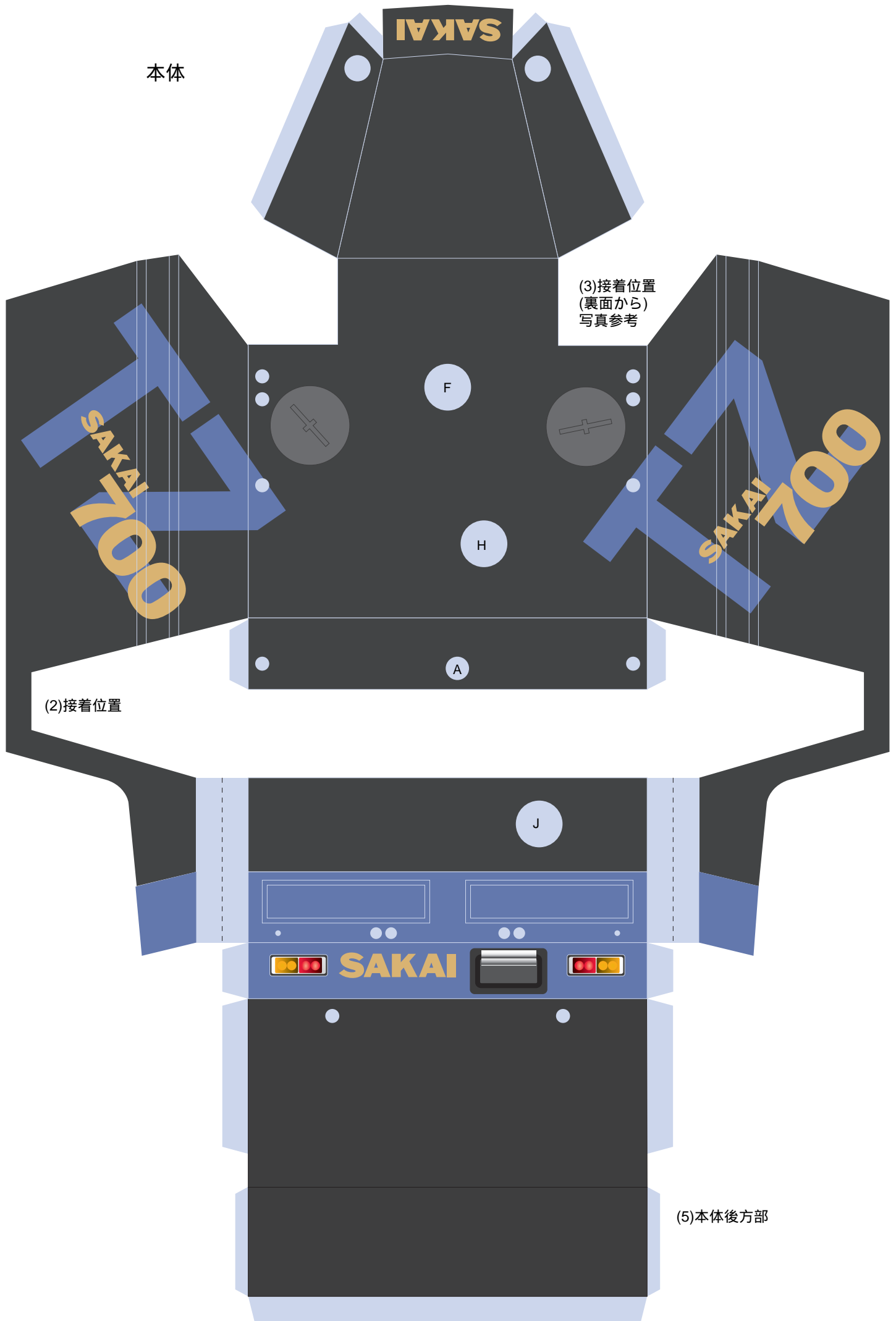

(3)接着位置
(裏面から)
写真参考

(2)接着位置

(5)本体後方部

(6)

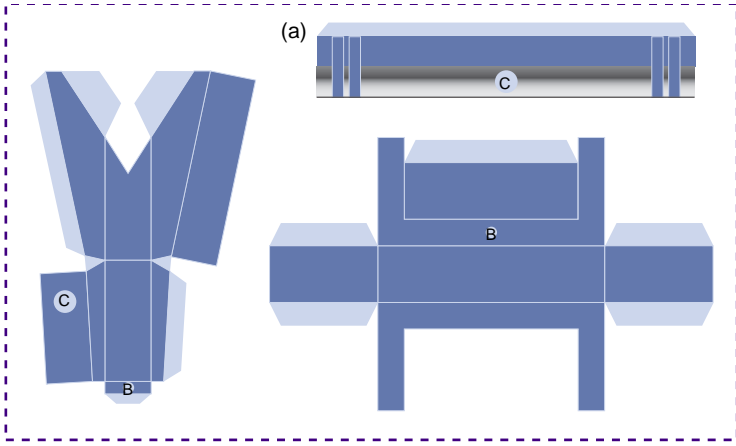

運転席

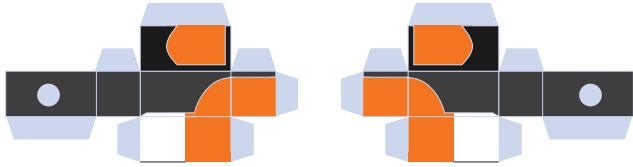
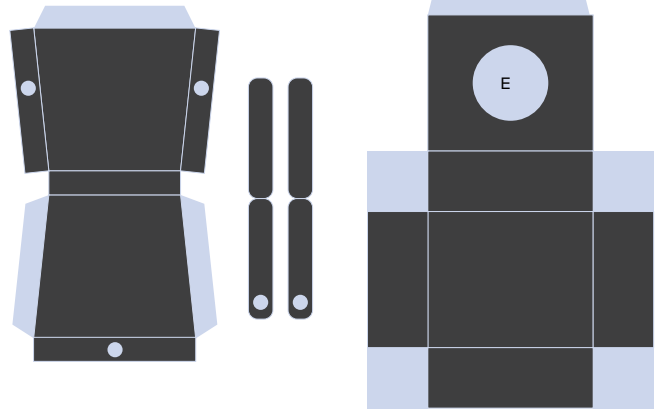

(7)泥除け

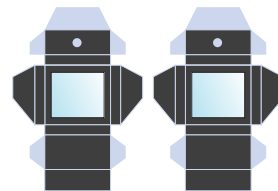
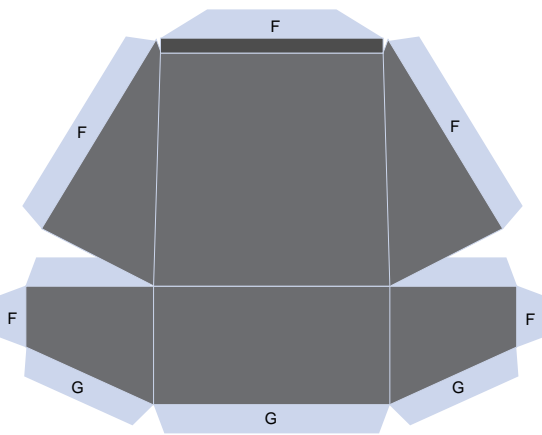
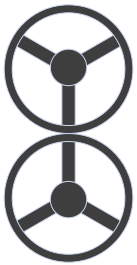
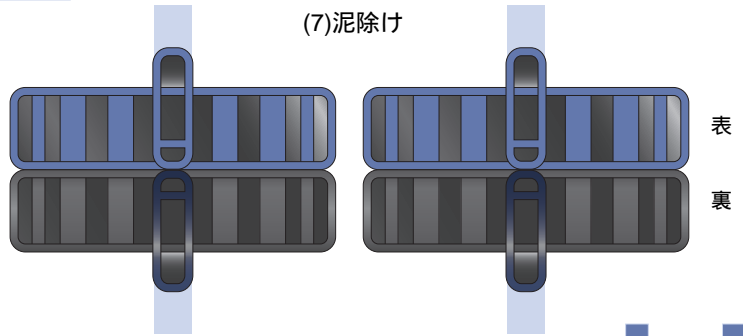

中央ミラー

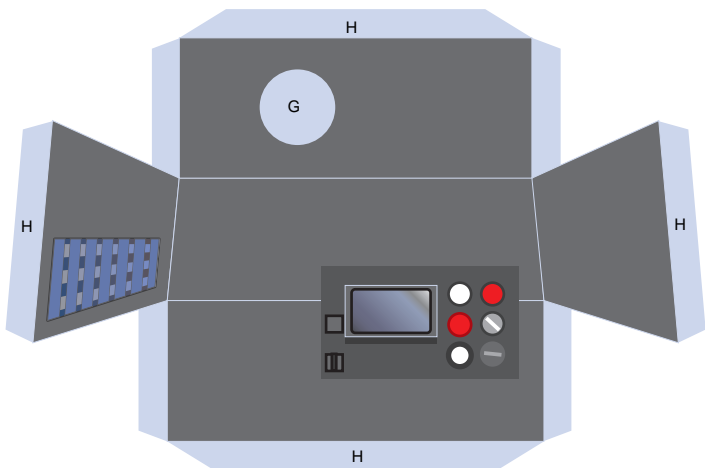
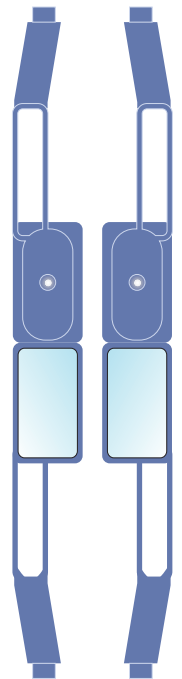

計器板

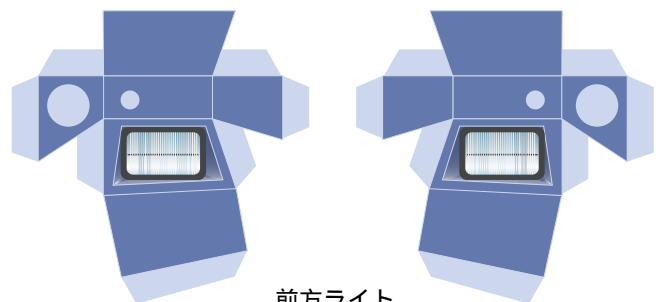

前方ライト

タイヤ

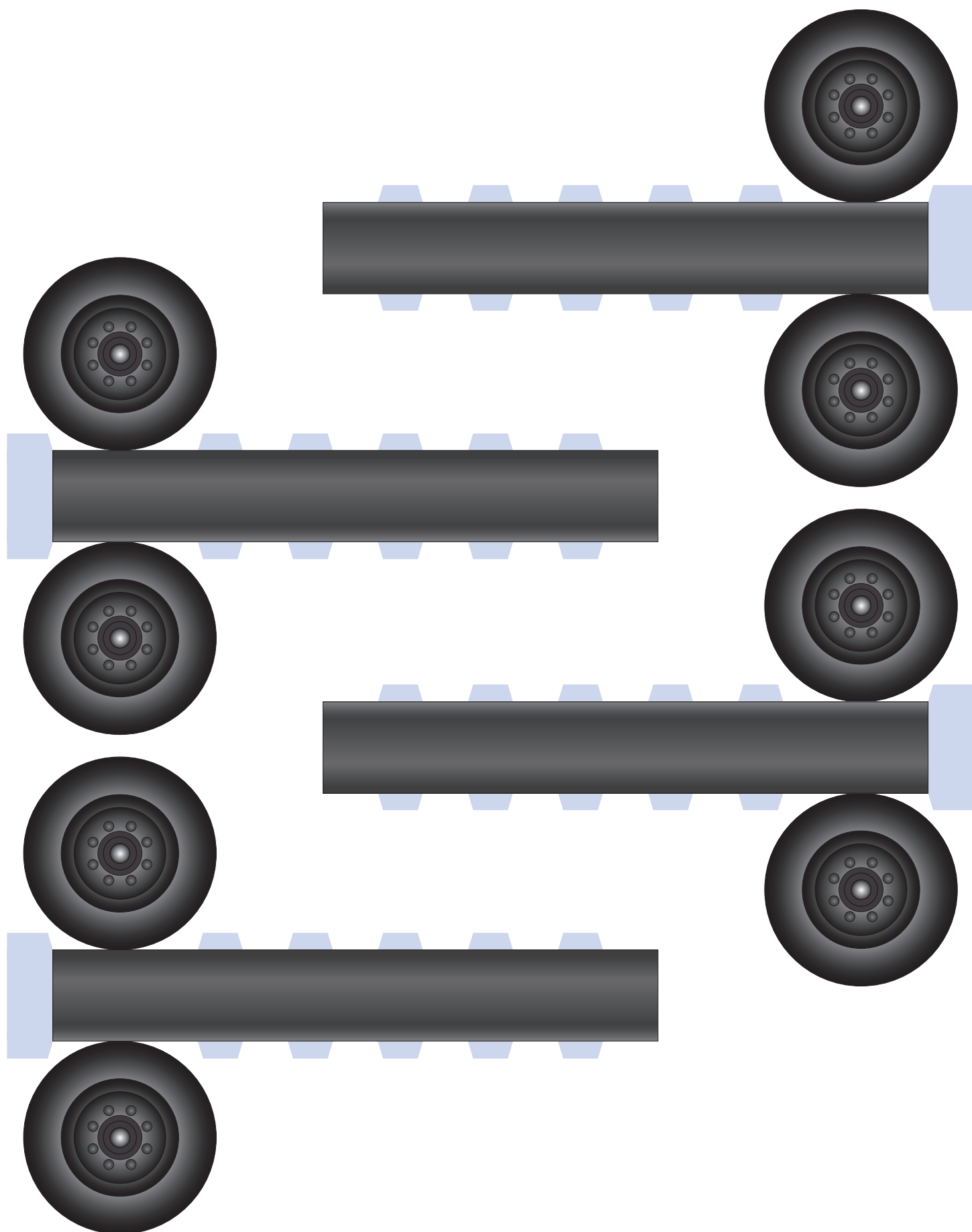

タイヤ

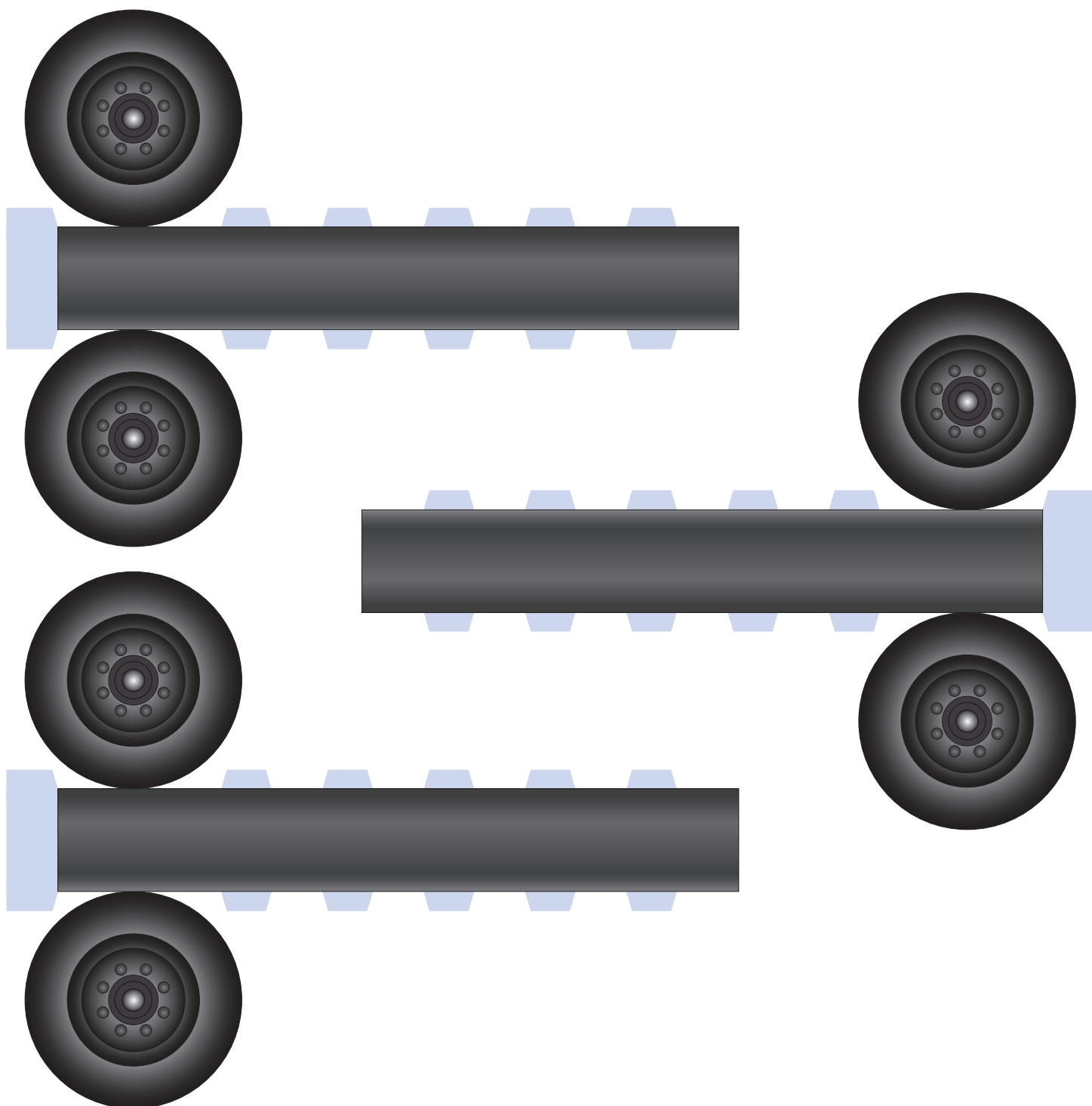

(4)

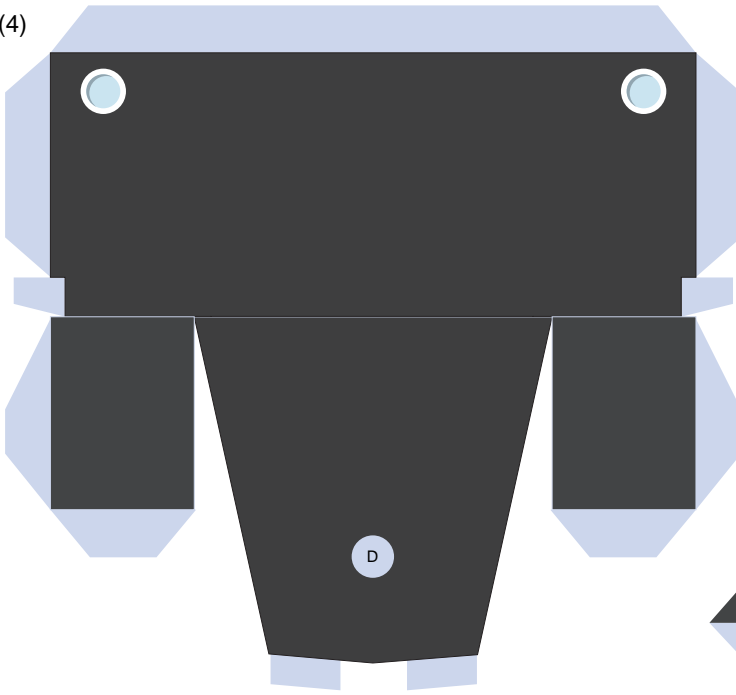

(3)

後

のりしろ

前

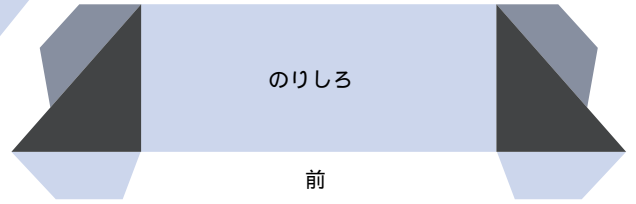

SAKAI HEAVY INDUSTRIES, LTD.

<http://www.sakainet.co.jp>

TZ700

底面



(2)

後

前

A

E

(1)

ステップ部

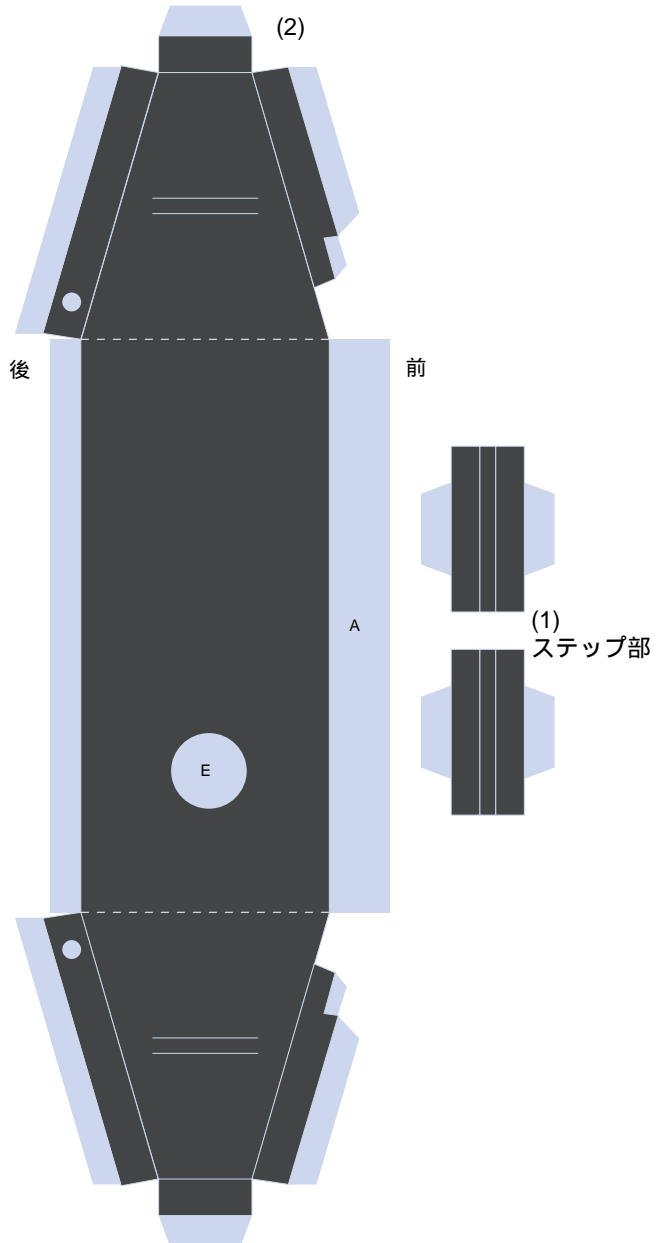

後方ミラー

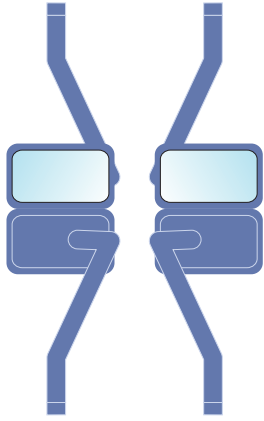

前方ミラー

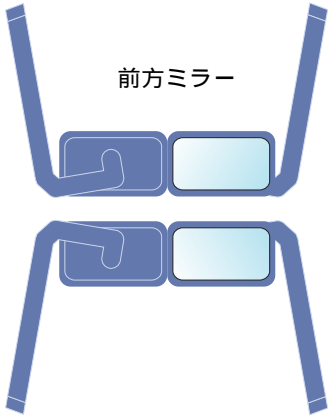

後方パイプ

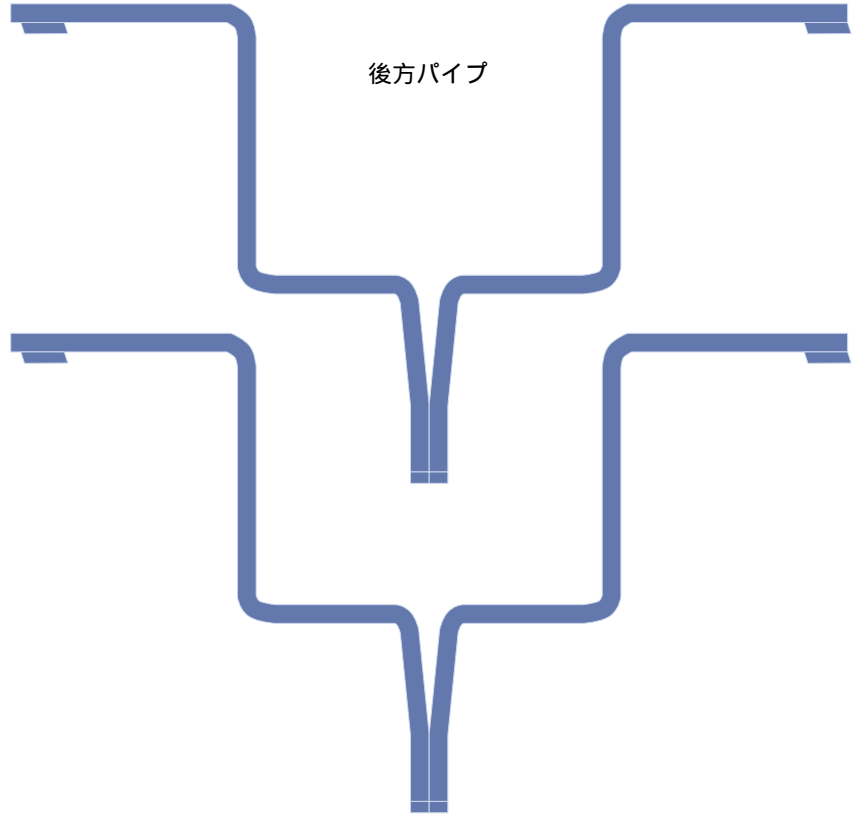

サイドパイプ

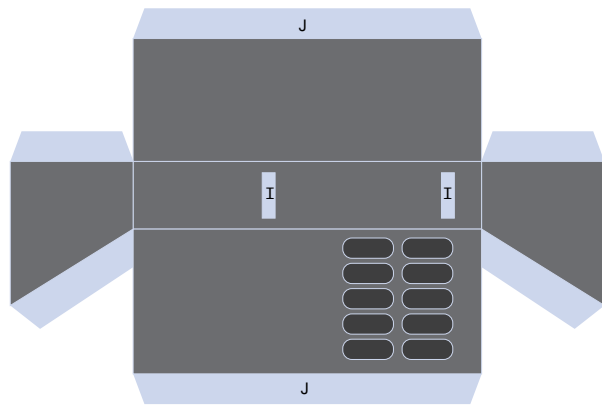
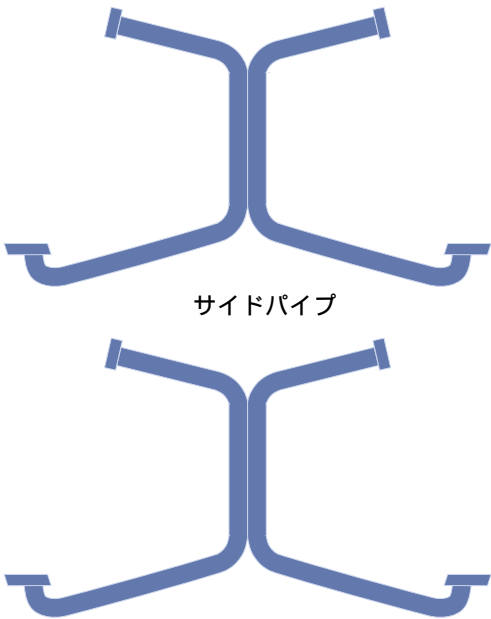

屋根

